



PROPERTY PROTECTION

LONG-LASTING SOLUTIONS

PROTECTING PEOPLE, PROPERTY, AND PROCESSES.

CONTENTS

03	PROPERTY PROTECTION
04	TROAX TOTAL
06	PROTECT YOUR PROPERTY
08	UNIQUE SOLUTIONS
10	TROAX CLASSIC
14	TROAX MEDIUM
18	TROAX SAFE
22	BIM
23	ACCESSORIES SILENCERS
24	SPARE PARTS SECURING PLATES
25	SKI STORAGE
26	SMART ACCESSORIES / POWERFUL VISUALIZATION
27	LOCAL & GLOBAL PRESENCE

Troax is a global developer and manufacturer of steel mesh panels for Machine Guarding, Warehouse Partitioning and Property Protection. This brochure presents our solutions for the market segment Property Protection. Our business concept is to develop innovative steel mesh panel solutions to protect people, property and processes. Our lightweight but strong mesh panels can be combined into unique solutions and are built to withstand the toughest tests and environments. Read more about our systems at www.troax.com

PROPERTY PROTECTION

FOR MORE THAN 65 YEARS WE HAVE BEEN DEVELOPING INNOVATIVE STEEL MESH PANEL SOLUTIONS FOR MACHINE GUARDING, WAREHOUSE PARTITIONING, AND PROPERTY PROTECTION. TODAY WE ARE THE MARKET LEADER, AND OUR PRODUCTS CAN BE FOUND ALL OVER THE WORLD – PROTECTING PEOPLE, PROPERTY AND PROCESSES.

TROAX TOTAL.

**LOCAL PRESENCE.
HIGH CAPACITY.
FAST DELIVERIES.**

WITHIN THE SEGMENT PROPERTY PROTECTION, TROAX OFFERS A COMPLETE SERVICE THROUGHOUT THE ENTIRE PROCESS, WHICH IS CALLED TROAX TOTAL.

Our systems are adapted and designed to suit your specific needs, with everything intricately planned down to the smallest detail. Our systems can be built to suit all kinds of application areas. Troax Total is a total solution within property protection, where every solution is flexible to suit your needs and requirements. With Troax Total, you will get a solution that is:

- **ASSEMBLED**
- **GUARANTEED**
- **SAFE**
- **FAST**
- **EASY**

TROAX IS THE ORIGINAL AND RELIABLE PARTNER FOR STORAGE SOLUTIONS.

- » Guaranteed products and installations to meet the customer's specific demands.
- » Extremely durable mesh panel solutions.
- » Products of the highest quality and functionality.
- » Easily combined systems, which makes the solutions flexible and efficient to meet the customer's expectations.
- » Anti-theft test according to SSF.
- » High capacity and fast deliveries.
- » Local presence – both service and support.
- » Troax is Your natural partner for storage solutions in new construction and renovation projects.



PROTECT YOUR PROPERTY.

TROAX OFFERS A WIDE RANGE OF STORAGE AND PROPERTY PROTECTION SYSTEMS. WHATEVER YOUR STORAGE NEEDS MAY BE, TROAX WILL CREATE A SOLUTION THAT FITS THEM.

Storage walls made from security mesh partitions have many advantages. Mesh panels provide good light and ventilation, as well as protection against damage and break-ins. Troax offers several mesh panel systems, including a wide range of doors and locks, with various levels of protection. Combined with Troax partitioning system, the mesh systems can be built to fit most properties and storage spaces, even those with sloping ceilings. We also provide storage solutions that are completely enclosed, and/or protected from public view. For immediate delivery, storage walls in our standard colour RAL 7037 are available at any time.



1 GARAGE

The system is based on modular mesh panels and secures garages against break-ins and vandalism. Regardless of the security level you choose – a standard or customised design – you will get a secure and flexible garage system.



2 STEEL PANELS

UR SP is a secure, durable, and easy-to-assemble storage solution, which is ideal for situations that require privacy protection. UR SP is easily combined with our other types of mesh storage panels.



3 LOFT SPACE

Our flexible systems are easily adapted to most properties and spaces – even those with a more complicated layout, such as loft spaces with sloping ceilings.



4 ENCLOSURE

Our partitioning wall system is flexible and can easily be adapted to locations that are difficult to access.

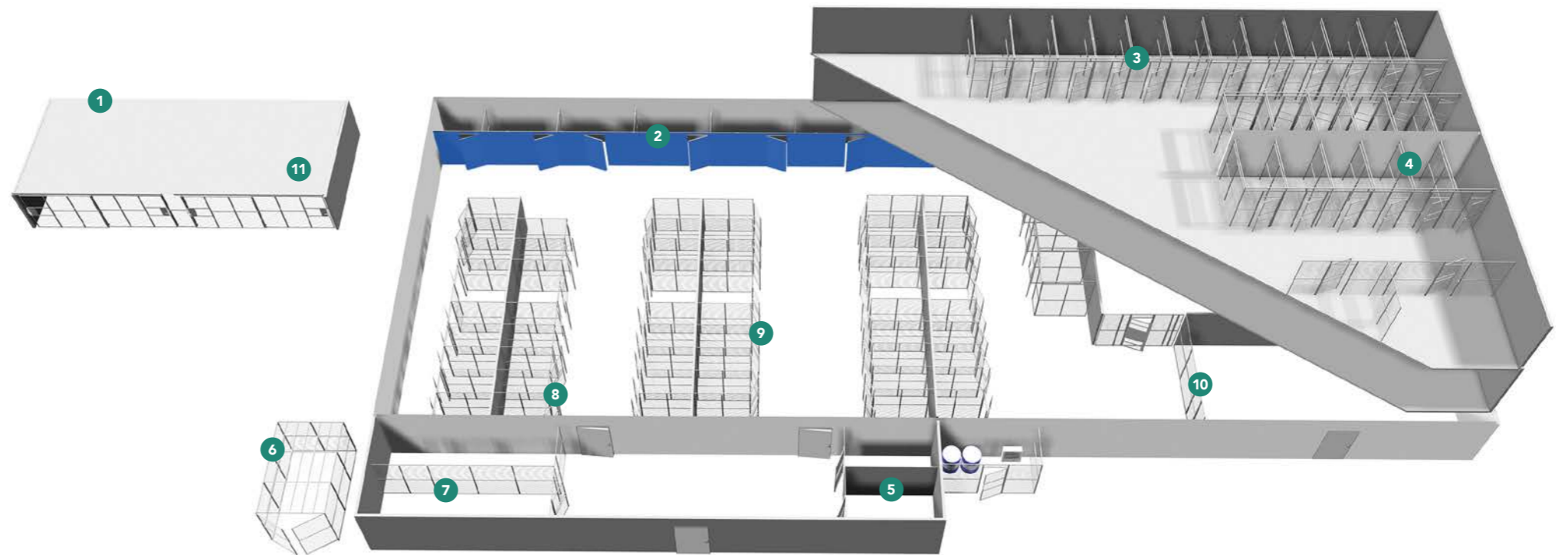

5 TYPE P

Type P is a price efficient, durable and easy to install storage system. The corrugated, full steel sheet panels make it impossible to see into the storage room. Type P is also compatible with our other types of mesh storage panels.



6 TROAX CAGE

Troax Cage is a quick and free-standing solution and can be used both indoors and outdoors. Its construction makes it particularly suitable for storing hazardous materials and protecting against theft or vandalism.

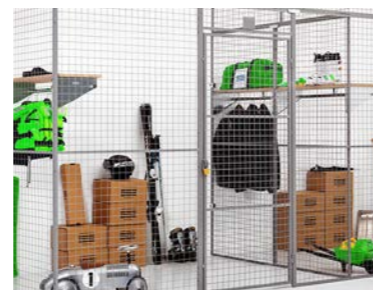

7 TROAX CLASSIC

This mesh panel fits areas with good external protection and little risk of damage. It can also be used as a partition wall in combination with other Troax systems.



8 TROAX MEDIUM

The medium panel is used primarily in areas that demand good protection against uninvited guests. In combination with approved locks, it significantly reduces the risk of break-ins.



9 TROAX SAFE

This is our safest product. It is certified according to the Swedish Theft Prevention Association's standard for storage installations that protect against break-ins. The system is suitable for spaces that are particularly vulnerable to break-ins.



10 DOORS

Our secure, thresholdless door systems in the Classic and Medium ranges make it easy to move property in and out of the storage space.



11 BICYCLE STORAGE

Troax offers the most secure protection for theft-prone properties such as bikes and pushchairs.

COMBINE OUR SYSTEMS FOR UNIQUE SOLUTIONS.

OUR THREE PROPERTY PROTECTION SYSTEMS CAN BE COMBINED IN A NUMBER OF WAYS TO SUIT YOUR SAFETY AND STORAGE NEEDS, WHICH IS AN INNOVATIVE WAY TO GIVE YOU AN AFFORDABLE AND FUTURE-PROOF SOLUTION.

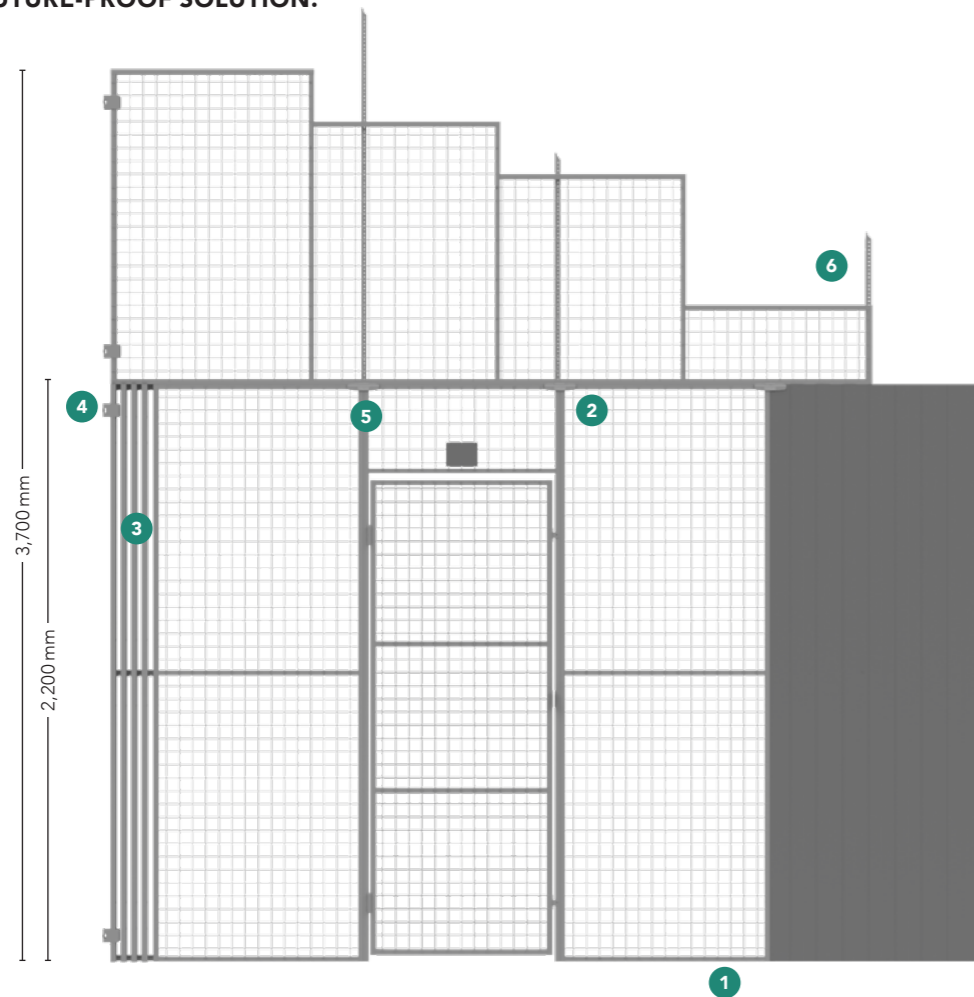

1 FLOOR SUPPORT

The simple and unique floor support makes it easy to adapt the system to various conditions, such as an uneven floor.



2 SNAPPER WITH ROOF FIXING

Snappers are used to fix panels together in order to make the partition walls safe and strong, which in turn makes the ceiling mounting extremely strong and durable.



3 FILLER KIT

The filler kit is used in combination with the filler pipe, which is secured into the smart profile, to fill gaps in the wall system.



4 WALL FIXING

With our wall fixings, panels can be adjusted and secured to adjoining structures for a perfect fit.



5 SCREWS AND FITTINGS

Our systems are based on self-tapping screws in combination with a variety of different fittings to provide extremely strong and flexible fixings.



6 U-PROFILE

Our U-profiles are used to conceal sharp edges where adaptations have been made.

DOOR (H×W)	DOOR TYPE
2,200×750 mm	Classic, Medium
2,200×900 mm	Classic, Medium, Safe, UR-P, UR SP

PANEL (H×W)	PANEL TYPE
2,200×200 mm	Classic, Medium, Safe, UR SP
2,200×300 mm	Classic, Medium, Safe, UR SP
2,200×500 mm	Classic, Medium
2,200×700 mm	Classic, Medium, Safe, UR SP
2,200×800 mm	Classic, Medium, Safe, UR SP
2,200×1,000 mm	Classic, Medium, Safe, UR SP
2,200×1,200 mm	Classic, Medium, Safe, UR SP
2,200×1,500 mm	Classic, Medium, Safe

Also available in galvanised finish and other RAL colours.

- MAXIMIZE STORAGE.
- EASY INSTALLATION.
- MAINTENANCE-FREE.

TROAX CLASSIC.

Troax Classic is an excellent choice of mesh partition for storage spaces in apartment buildings, cellars and attics that already have exterior protection or where there is a low risk of tampering. The mesh panels provide excellent visibility, as well as good lighting and ventilation conditions. In case of fire, mesh systems make for easy detection and extinction. Doors without thresholds facilitate the transfer of property in and out of the storage area.

- **ECONOMICAL.**
- **EASY INSTALLATION.**
- **IN STOCK READY TO SHIP.**

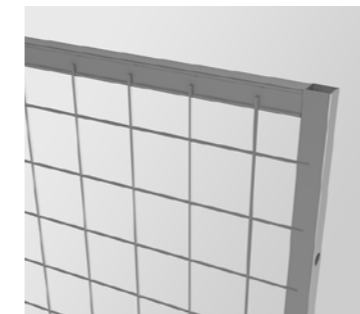

PANEL CLASSIC UR 350
Forms the basis of the Classic system.

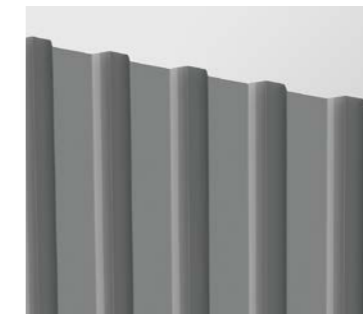

PANEL CLASSIC P
The full cover option to Classic system.
Thickness 0.5 mm.



SECURING PLATE
The classic door is supplied prepared for padlocks.

PANEL (H×W)	
Panel Classic	2,200×200 mm
Panel Classic	2,200×300 mm
Panel Classic	2,200×500 mm
Panel Classic	2,200×700 mm
Panel Classic	2,200×800 mm
Panel Classic	2,200×1,000 mm
Panel Classic	2,200×1,200 mm
Panel Classic	2,200×1,500 mm

DOOR WITH PADLOCK FITTINGS (H: 2,200 MM)	
Door Classic P 750 R only mesh (opening H: 1,860 mm)	
Door Classic P 750 L only mesh (opening H: 1,860 mm)	
Door Classic P 900 R (opening H: 2,000 mm)	
Door Classic P 900 L (opening H: 2,000 mm)	

COMPONENT INFORMATION	
Frame	19×19×1.0 mm
Wire	2.5×2.5 mm
Mesh	50×50 mm
Mesh option	50×100 mm (only wall panel)
Surface treatment	Powder coating Grey RAL 7037

Also available in galvanised finish and other RAL colours.

The Troax Classic is an entry-level mesh panel, based on a welded tube construction of 19×19 mm. The mesh consists of press-welded wires, each 2.5 mm, with the mesh equivalent to 50×50 mm.

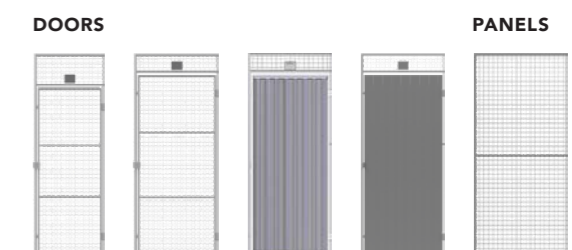

» STEEL MESH PANELS
FORM THE BASIS OF
ALL OUR SYSTEMS. «

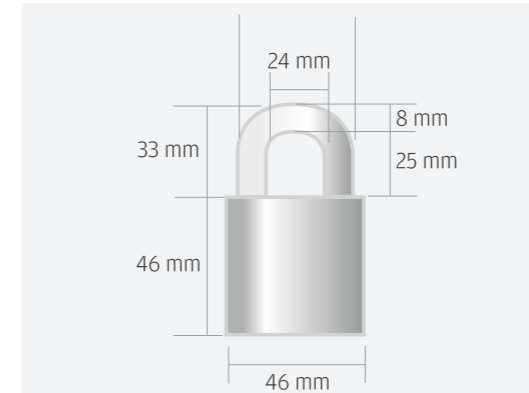

RECOMMENDED PADLOCKS



THRESHOLDLESS DOOR SYSTEMS

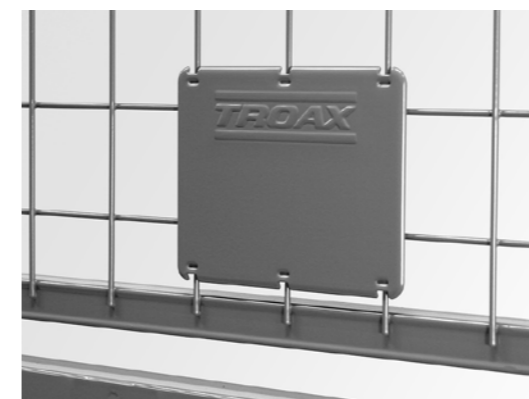

WELDED NUMBERED PLATES AS STANDARD



FLEXIBLE CHIPBOARD SHELF WITH BRACKETS

PANELS

If you need a mesh partition for a space with a low risk of break in, choose the UR 350 panel, which is the backbone of Troax Classic. This panel provides a light and airy storage environment. UR 350 can also be used as a partition wall between our other systems. The frame is constructed from 19×19 mm welded tubing. The mesh consists of press-welded 2.5 mm wire, and the mesh size is equivalent to 100×50 mm or 50×50 mm.

DOORS

Our secure thresholdless door systems facilitate passage, particularly for people with physical disabilities. The UR 350 door has a frame made from 30×20 mm steel tubing and two specially designed cross tubes, making it stable and secure. The mesh size of 50×50 mm is almost impossible to force by hand. The doors are delivered preassembled and ready for mounting. Doors are available in heights from 2,200 mm and come in a range of colours, standard colour being grey.

PROTECTION FROM VIEW

Type P consists of panels made of corrugated aluzinc sheeting, intended as alternative front panels. The sheet metal panels are compatible with the UR 350 and UX 450 mesh panels as partition walls or roofs.

ACCESSORIES

Troax modules and accessories can be used to adapt the installation to almost any type of premises: narrow or wide, low or high ceilings, as well as sloping floors. Our system is based on our self-tapping screws, combined with a variety of different mountings to provide incredibly strong and versatile fixings. Our snappers are used to fix panels together safely and strongly; this also makes the ceiling mounting incredibly strong. The range of accessories also includes different shelving systems with brackets for versatile placement, as well as a special system for storing skis.

TROAX MEDIUM.

Troax Medium is a mesh partition system for storage spaces in apartment buildings, cellars and attics where there needs to be a reasonable level of protection against uninvited guests. Combined with approved locks and reinforced front panels, it minimises the risk of break-ins. The mesh provides good visibility, which in turn creates a sense of security. The mesh panels allow light to penetrate and air to circulate. Fires can be quickly detected and extinguished from outside the storage space.

- **VERSATILE.**
- **GOOD VISIBILITY.**
- **MAINTENANCE-FREE.**

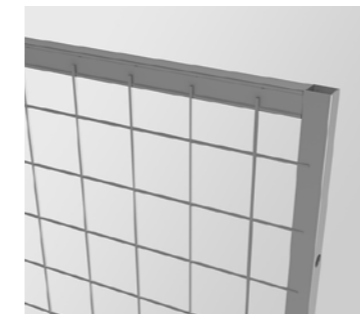

PANEL UX 450
Forms the basis of the Medium system.



UR SP
For a fully-covered solution to protect your privacy.



FLEXIBLE CHIPBOARD SHELF
With brackets.

PANEL (H×W)	
Panel Medium	2,200×200 mm
Panel Medium	2,200×300 mm
Panel Medium	2,200×500 mm
Panel Medium	2,200×700 mm
Panel Medium	2,200×800 mm
Panel Medium	2,200×1,000 mm
Panel Medium	2,200×1,200 mm
Panel Medium	2,200×1,500 mm

DOOR WITH PADLOCK FITTINGS (H: 2,200 MM)	
Door Medium P 750 R only mesh (opening H: 1,860 mm)	
Door Medium P 750 L only mesh (opening H: 1,860 mm)	
Door Medium P 900 R (opening H: 2,000 mm)	
Door Medium P 900 L (opening H: 2,000 mm)	

DOOR READY FOR EURO CYLINDER (H: 2,200 MM)	
Door Medium EC 900 R (opening H: 2,000 mm)	
Door Medium EC 900 L (opening H: 2,000 mm)	

DOOR READY FOR ASSA CYLINDER (H: 2,200 MM)	
Door Medium AC 900 R (opening H: 2,000 mm)	
Door Medium AC 900 L (opening H: 2,000 mm)	

COMPONENT INFORMATION	
Frame	30×20×1.25 mm
Wire	3.0×3.75 mm
Mesh	50×50 mm
Surface treatment	Powder coating Grey RAL 7037

Also available in galvanised finish and other RAL colours.

The Troax Medium Panel UX 450 is a stronger variant based on a welded tube construction of 30×20 mm. The mesh consists of press-welded wires 3×3.75 mm, with the mesh equivalent to 50×50 mm.

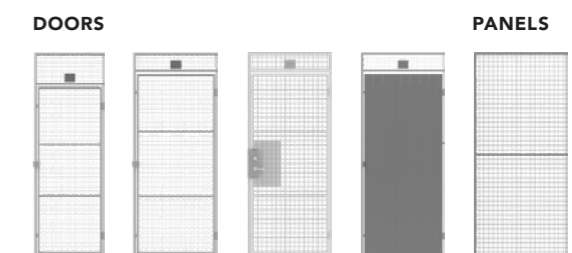

PANELS
Troax Medium is based on the UX 450 mesh panel, an alternative that suits the need for a higher level of protection. Troax UX 450 is a stable mesh partition that protects against break-ins. The panels are built from welded 30×20 mm tubing. The mesh is made from press-welded 3×3.75 mm wire. The mesh size is 50×50 mm, which makes it almost impossible to get a hand through it. The smooth assembly makes UX 450 adaptable to almost every type of premises. This storage system suits both narrow and wide spaces, regardless of ceiling height. It is compatible with Troax UR 350 and Troax UX 550.

DOORS
The UX 450 door is included in the Troax Medium system to be used in combination with UX 450 mesh panels. The door is excellent for use in spaces that have a relatively strong exterior protection. The padlock door has a specially designed cover to protect the padlock, minimising

the risk of break-ins. The leaf has a frame made from 30x20 mm steel tubing and two specially designed cross tubes, making it stable and secure. These doors are thresholdless, which makes them easy for people with disabilities to use, and are delivered ready for installation.

PROTECTION FROM VIEW

UR SP is a solid partition panel that provides exceptional protection against break-ins. This is mainly used as a front wall in spaces that already have a reasonable level of exterior protection. The sheet metal panels make it impossible for anyone on the outside to view what is inside the storage. This system also includes solid doors as an alternative to mesh doors. The door is equipped with a latch for a padlock. UR SP can easily be combined with our other types of storage partitions made of mesh.

ACCESSORIES

Troax accessories make it possible to adapt mesh partitions to the majority of premises, even those with sloping floors or ceilings. For example, the unique floor foot allows step-free adjustments to be made in case of an uneven floor. Self-tapping screws, combined with a variety of different mountings make installation simple. Our Snapper mounting quickly attaches panels to one another. Special sections are available to fill any gaps that arise between the panels and the walls and ceiling. The range of accessories also includes different shelving systems with brackets for versatile placement, as well as a special system for storing skis.



ASSA CYLINDER LOCK
Strong lock casing for ASSA cylinder.



EURO CYLINDER LOCK
Strong lock casing for EURO cylinder.



PADLOCK WITH COVER
The Medium door is supplied with a strong securing plate protected by welded casing.



SECURING PLATE FOR PADLOCKS
UR SP metal door with a padlock plate.

» OUR PANELS ARE
MADE OF 100%
HIGH-QUALITY STEEL. «

TROAX SAFE.

Troax Safe is our most secure system of storage partitions. It is based on the UX 550 mesh panel, which complies with the requirements of the Swedish Theft Prevention Association's break-in protection standard for storage fittings. Troax Safe is suitable for spaces that are particularly vulnerable to attempted break-ins, such as storage spaces in apartment buildings, as well as bicycle storage areas. Just like our other systems, Troax Safe provides a light and airy storage environment where it is easy to detect and extinguish a fire.

- **STRONG, SECURE.**
- **MODULAR.**
- **QUALITY CONSTRUCTION.**



PANELS

Security was the main focus in the development of UX 550, our most advanced and secure mesh partition. The partition has special sections in order to minimise the risk of potential break-ins. The system has been tested and approved in accordance with SSF 1990-06-30/B. UX 550 is primarily used in storage spaces in apartment buildings, cellars and attics that require an extra high level of security. Using the Troax mesh partition system, you can create compatible storage spaces pretty much anywhere. For example, Troax Safe can be complemented with partitions from the UX 450 and UR 350 series.

DOORS

The UX 550 cylinder door and the UX 500 padlock door are designed to be used in combination with UX 550 mesh panels in the Troax Safe system. The system with the UX 500 padlock door has been tested and approved by the Swedish Theft Prevention Association (SSF) and the door can be used in spaces that require an extra high level of security. The leaf has a frame made from 30×20 mm steel tubing and two specially designed cross tubes, making it stable and secure. The door is also equipped with a specially designed cover that provides extra protection to the padlock. The mesh size is the same as the partition panels, 50×50 mm. The doors are easy to use by people with physical disabilities, and are delivered ready for mounting.

ACCESSORIES

Troax Safe is part of a system of specially adapted assembly mountings, making it possible to install secure storage spaces in almost every type of premise: narrow or wide, low or high ceilings, as well as sloping floors. The system has been tested and approved by the Swedish Theft Prevention Association (SSF) and is used in areas which are particularly exposed to break-in attempts. The range of accessories for Troax Safe also includes shelving systems with brackets for versatile placement, as well as a special system for storing skis.



PANEL (H×W)	
Panel UX 550	2,200×200 mm
Panel UX 550	2,200×300 mm
Panel UX 550	2,200×700 mm
Panel UX 550	2,200×800 mm
Panel UX 550	2,200×1,000 mm
Panel UX 550	2,200×1,200 mm
Panel UX 550	2,200×1,500 mm

DOOR TROAX SAFE UX 550 (H×W)	
Door UX 500, P 900	2,200×900 mm
Opening size	1,860×860 mm

DOOR TROAX SAFE UX 550 (H×W)	
Door UX 550, EC 900	2,200×900 mm
Opening size	2,000×810 mm
Door UX 550, AC 900	2,200×900 mm
Opening size	2,000×810 mm

COMPONENT INFORMATION UX 550	
Frame	30×20×1.5 mm
Wire	5.0×5.0 mm
Mesh	50×50 mm
Surface treatment	Powder coating Grey RAL 7037

Also available in galvanised finish and other RAL colours.



» OUR PRODUCTS ARE DEVELOPED WITH YOUR SAFETY IN FOCUS. «

TROAX SAFE

Our well-renowned Troax Safe is the market's strongest alternative, offering a system that includes smart accessories for the most theft-prone environments. To the floor support, screws and fittings have we added the uniquely designed profile system, which provides corners and wall fixings with superior strength. The door is available with a padlock (UX500) or a cylinder lock (UX550).

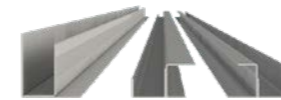

PROFILE SYSTEM
Our strong profile system secures the most exposed parts of the storage wall.



SCREWS AND FITTINGS
Our screws and fittings enable rapid and secure installation.



FLOOR SUPPORT
The unique floor support design enables height adjustment for uneven floors.

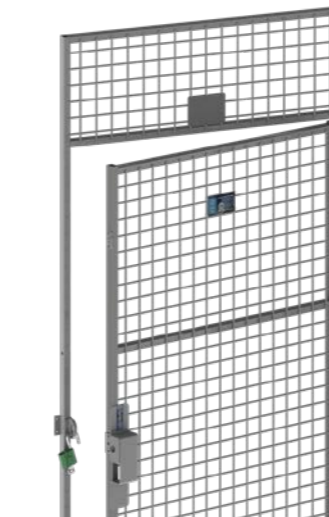
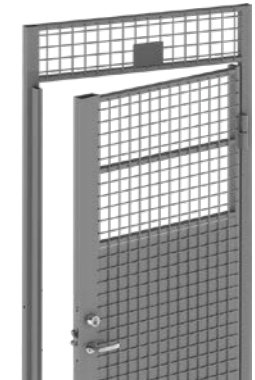

TROAX SAFE UX500
The UX500 padlock door is, together with the UX550 panels and its Troax Safe assembly system, certified by Swedish Theft Prevention Association (SSF).

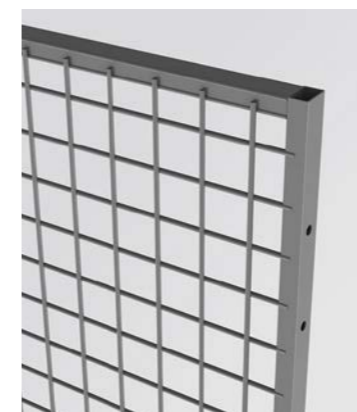

PANEL
The systems are based on UX550, but can be combined with UX450 or UR350.

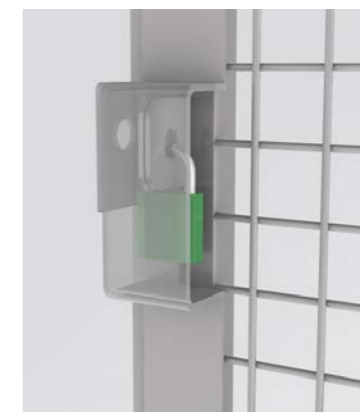

PADLOCK WITH COVER
Door Troax Safe UX500 have a sturdy casing to protect the padlock.



TROAX SAFE UX500
The door is a SBSC-certified product, and the preferred solution for demanding environments.

BIM.

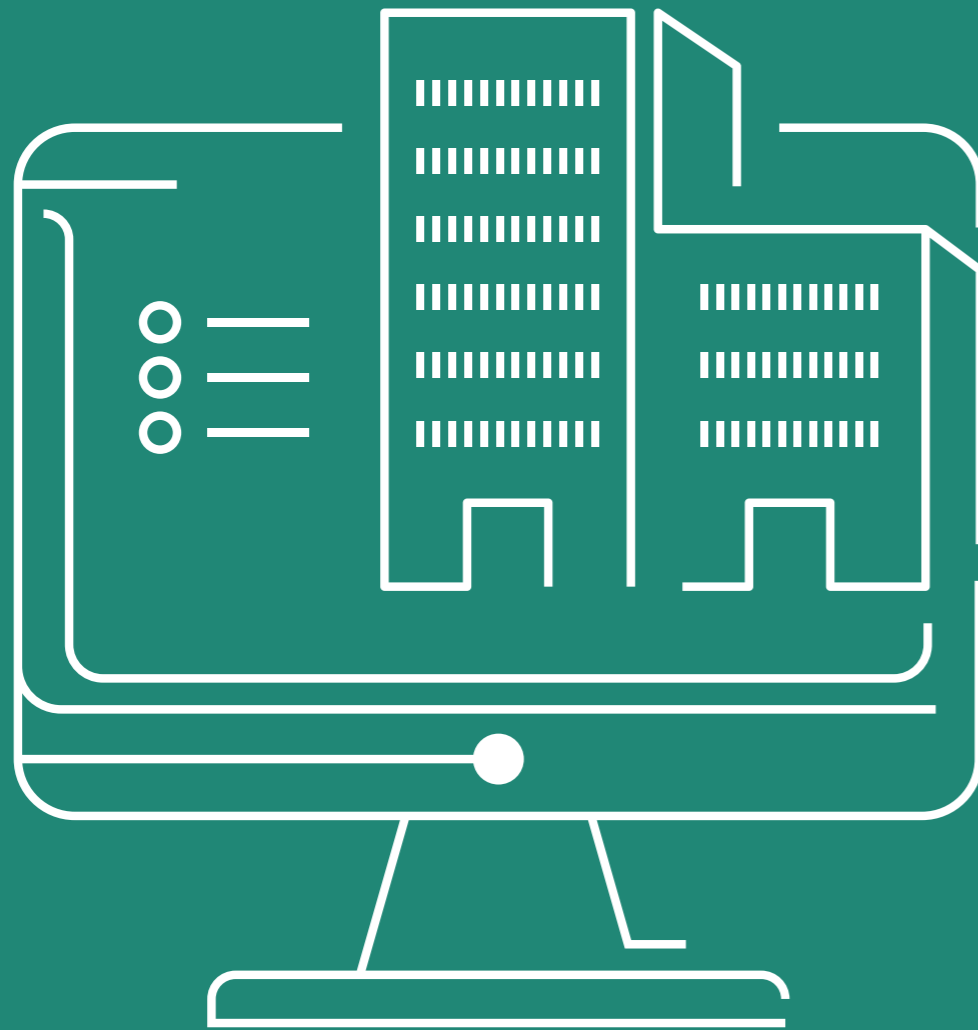

At troax.com you can download BIM files (Building Information Models) in the format ARCHICAD and AUTODESK REVIT. These small CAD files include just the necessary physical and functional characteristics and are good to use when large building drawings are put together.

ACCESSORIES SILENCERS.

TROAX HAS A FAMILY OF SILENCERS THAT WILL REDUCE THE UNPLEASANT SOUND OF METAL AGAINST METAL OR METAL AGAINST CONCRETE. THESE ACCESSORIES WILL HELP TO CREATE A BETTER ENVIRONMENT WITH REDUCED NOISE IN THE BUILDING. WE CAN SEE A TREND THAT MORE AND MORE CUSTOMERS ARE PRESCRIBING NOISE DAMPING FOR THEIR PROJECTS.

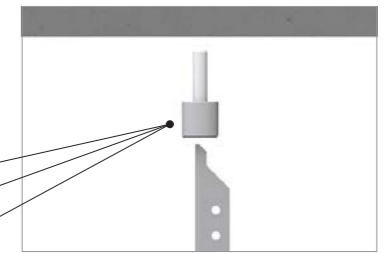

NOISE-DAMPING CEILING MOUNT
A rubber mount that minimises noise propagation up into the building.

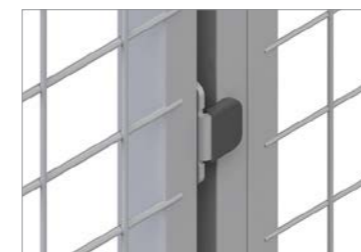
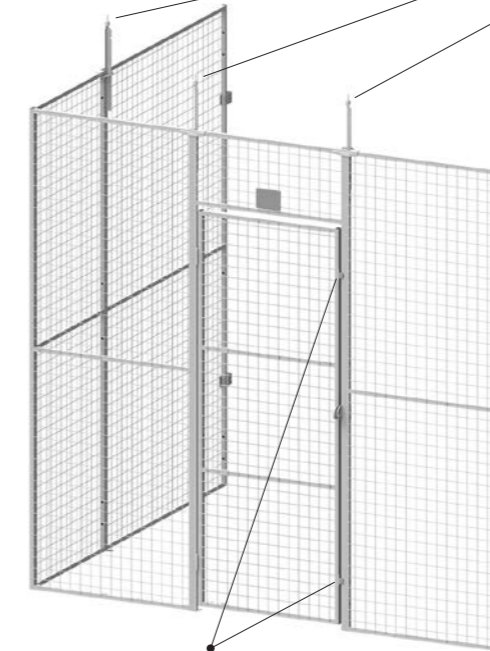

QUIET CLOSING
Rubber noise-damping doorstop to minimise noise when closing.

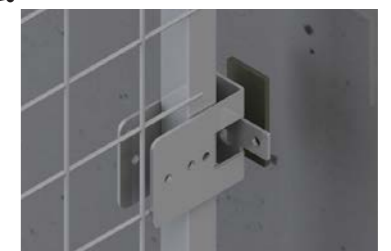

NOISE-DAMPING RUBBER LIST
A rubber list attached to the wall fixing to minimise noise.

SPARE PARTS SECURING PLATES.

Troax can provide you with spare parts if an accident has occurred and the need for new securing plates is urgent. No welding is needed, only a hole to drill. The key to this solution is the insert nut, which is self-inserted into the tube by the tightening of the bolt. Then the securing plate can't be loosened without first opening the door.

Another spare part is the cover protection for securing plates. So, it is possible to replace the old one or just upgrade the safety of an existing door without a cover.

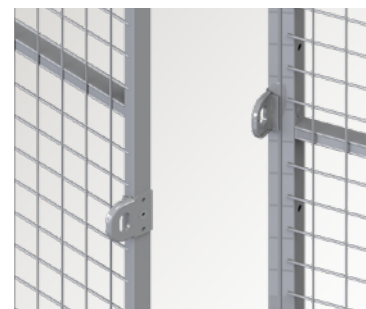

FOR CLASSIC, DOOR UR 350.

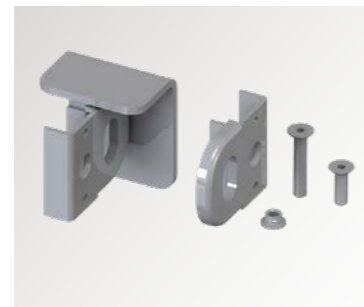

FOR MEDIUM, DOOR UX 450.



FOR SAFE, DOOR UX 500.

SKI STORAGE.

With our smart and safe way of assembling loose hinges, securing plates and door stops, by using insert nuts, it is now possible to customize different storage spaces depending on the specific need required. The doors can be created out of every of our standard wall panel widths, which are 200 mm, 300 mm, 500 mm, 700 mm, 800 mm, 1,000 mm, 1,200 mm or 1,500 mm. The application shown at this page is guest storage in a Ski Lodge. However, possible applications can only be limited by your imagination.

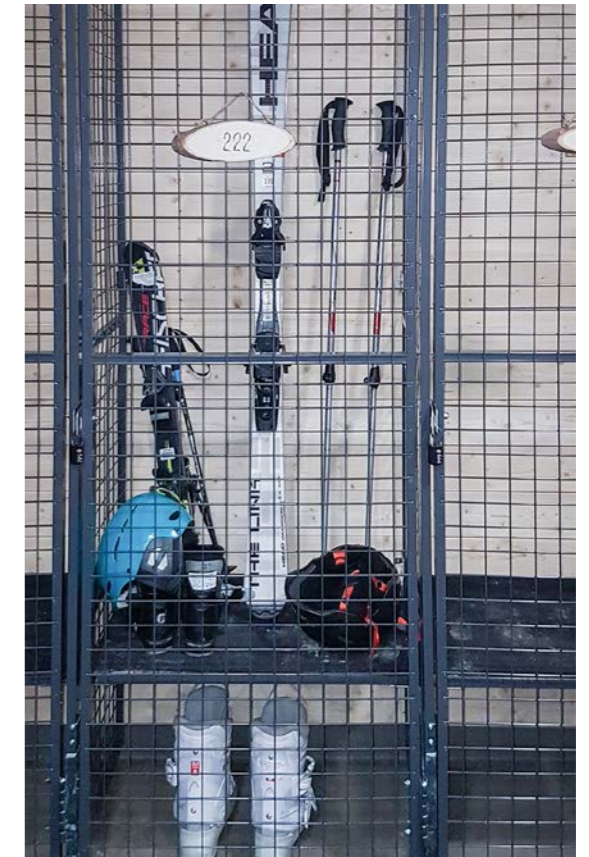
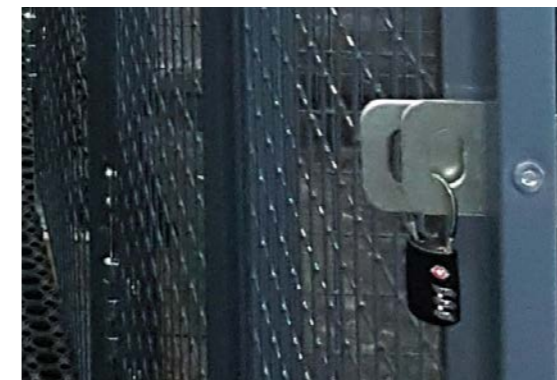

SMART ACCESSORIES.

TROAX' POPULAR STORAGE SYSTEMS PROVIDE TENANTS WITH THE HIGH LEVEL OF PROTECTION AND SECURITY THEY EXPECT. ONCE YOU'VE FOUND THE DOOR THAT BEST FULFILLS YOUR NEEDS, WE'RE ALSO ABLE TO OFFER YOU A WIDE RANGE OF SMART AND UNIQUE ACCESSORIES. CONTACT US FOR MORE INFORMATION. WWW.TROAX.COM



MODIFICATION ON SITE
With the END Profile and U Profile you can adjust the width and height on site.



NUMBER PLATE
An optional extra that attaches to the door leaf if it is of a custom height.



STORE ROOM NUMBERING
We can supply optional numbering for all doors.



DOOR CLOSER
Ensure that the door always closes behind you for greater peace of mind.



DOOR REINFORCEMENT, KIT COMBINE
Enables you to cut a door leaf to size in place with retained frame strength.

POWERFUL VISUALIZATION.

DRAWINGS AND OVERVIEW IN 2D AND 3D



LOCAL & GLOBAL PRESENCE.

TROAX IS REPRESENTED IN MORE THAN 40 COUNTRIES AND HAS 24 SALES COMPANIES OF ITS OWN. WE AIM TO STRENGTHEN OUR POSITION WORLDWIDE AND EXPAND OUR BUSINESS ON EACH CONTINENT.



At Troax, we meet your needs through local sales offices, backed up by daily deliveries from the world's largest warehouse for mesh panels, Troax in Hillerstorp, Sweden.

STRONG MARKET SEGMENTS

Our systems are marketed in three segments: Machine Guarding, Warehouse Partitioning and Property Protection.

1. MACHINE GUARDING

Today's modern industry, with its advanced processes, places significant demands on safety. In particular, there is a great need for controlled access for authorised personnel. Our mesh panels are based on a carefully developed modular system that also includes special adaptations.

2. WAREHOUSE PARTITIONING

Troax can meet all requirements for storage and security. We are suppliers to all types of industry – from traditional manufacturers that require large-scale flows and volumes through their factories, to facilities with high-bay storage and retail storage. We can meet all your requirements and we offer complete solutions.

3. PROPERTY PROTECTION

Whether a question of new development or renovation of an existing installation, we are convinced that you will find our products easy to work with. Your unique needs and our creativity have contributed to our constant product development, giving rise to our motto: "Secure storage must be simple."

MAKING YOUR WORLD SAFE

